

# MAINTENANCE ENGINEERING'S

*PREMIRA*<sup>®</sup>

# T-10 FLUORESCENT LAMPS

## • 69% BRIGHTER

- 21% Boost in Efficiency
- Increased Seeable Lumens

## • FULL SPECTRUM

- Crisp White Light

## • LONG LIFE DESIGN

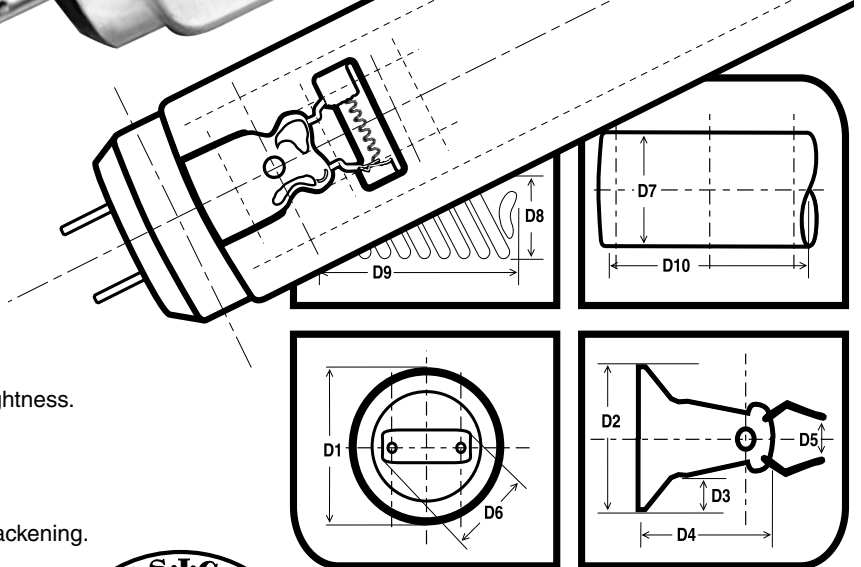
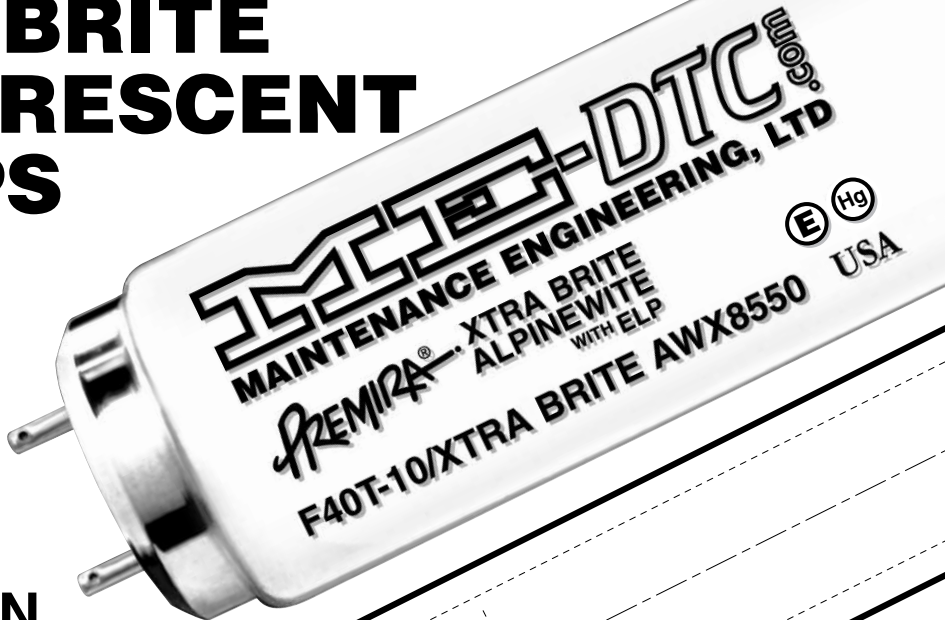

## ADVANCED TECHNOLOGY

**EXTENDED LIFE PHOSPHORS (ELP)** for improved lumen maintenance.

**RARE EARTH PHOSPHORS** for increased brightness.

**LOW PROFILE T-10 SIZE** for easy installation.

**CATHODE GUARD SHIELD** for reduced end blackening.

**HIGH EFFICIENCY DESIGN** for more light output.

**BRASS END PINS** for reliable operation.

**PRECISE FILL GASES** for easier starting.



**Standard Lamp**  
First Burnout

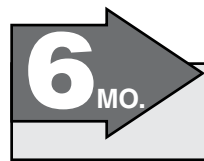

**M.E. GUARANTEES**

**84**  
MONTHS



T-10 FLUORESCENT

UNITED STATES ... 1-800-437-4794  
 CANADA ..... 1-800-268-4749  
 TORONTO ..... 1-416-675-1623

**M.E.-DTC**  
 MAINTENANCE ENGINEERING, LTD

# MAINTENANCE ENGINEERING'S

# PREMIRA®

## T-10 FLUORESCENT LAMPS



## LIGHT BOOST

BECAUSE T-10 LAMPS ARE BRIGHTER...

whitens yellowed  
fixture lens



- CRISP WHITE LIGHT
- IMPROVED COLOR RENDITION
- INCREASE LIGHT OUTPUT UP TO 69%



## • IMPROVED LIGHT QUALITY

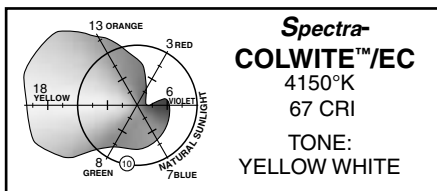

- DEFICIENT IN RED AND BLUE CONTRIBUTING TO EYESTRAIN.
- EXCESS YELLOW CAUSES COLOR DISTORTION AND GLARE.

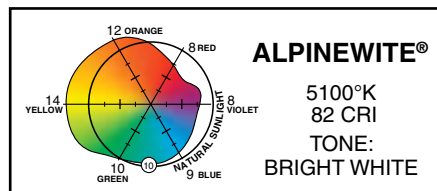

- BALANCED WHITE LIGHT MAKES COLORS BRIGHTER AND MORE VIVID.
- REDUCED YELLOW LIGHT CUTS GLARE AND EYESTRAIN.

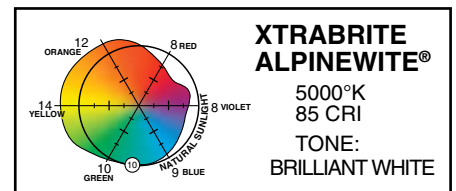

- NEW XTRABRITE PHOSPHOR BLEND.
- CRISP WHITE LIGHT SIMILAR TO ALPINEWITE.
- IMPROVED COLOR RENDITION GIVES DEEP, VIVID COLORS.
- BOOSTS USABLE LIGHT LEVELS OVER 69%.

## • INCREASED SEEABLE LIGHT

T-12 Spectra-COLWITE™ ENERGY SAVER

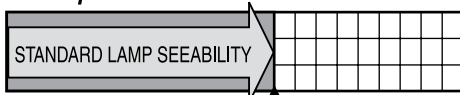

SEEABLE LUMENS 3579

T-10 ALPINEWITE® 8251



SEEABLE LUMENS 4544

T-10 XTRABRITE ALPINEWITE® AWX8550



SEEABLE LUMENS 6050

# 84 MONTH GUARANTEE

UNITED STATES ... 1-800-437-4794  
CANADA ..... 1-800-268-4749  
TORONTO ..... 1-416-675-1623

**MEE-DTC.com**  
MAINTENANCE ENGINEERING, LTD

To Order Call